

# ORIGINAL KETTLE

ASSEMBLY GUIDE  
ENSEMBLE GUIDE  
MONTAGEANLEITUNG

E-4710  
E-5710



47 cm

57 cm



Read the owner's guide before using the barbecue.

Lisez le guide d'utilisation avant d'utiliser le barbecue.

Bitte lesen Sie das Benutzerhandbuch, bevor Sie den Grill verwenden.



**71068**

03/20/19

bg / cs / el / et / hr / hu / lt / lv / ro / sk / sl / tr

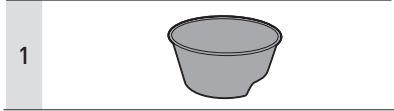
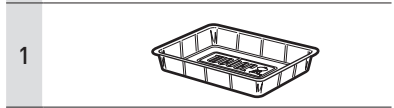
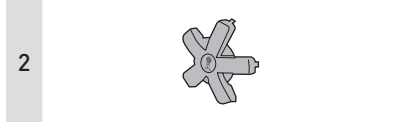
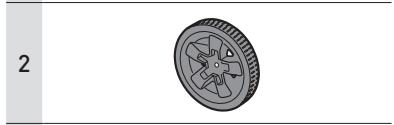
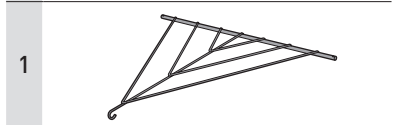
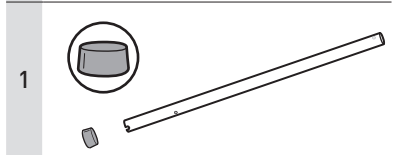
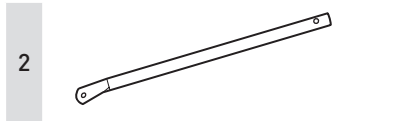
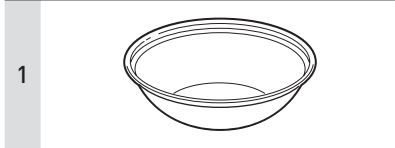
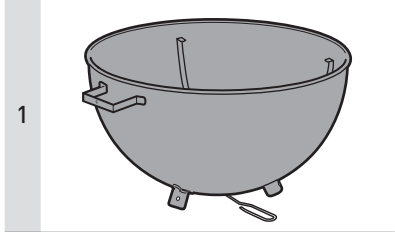
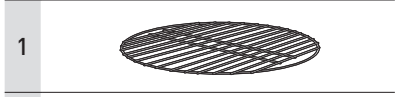
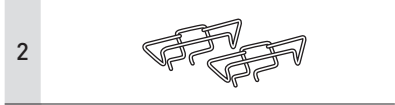
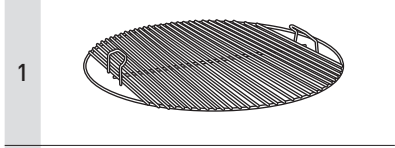
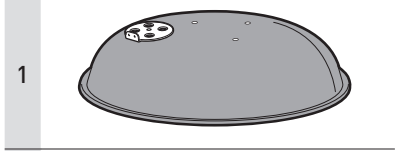
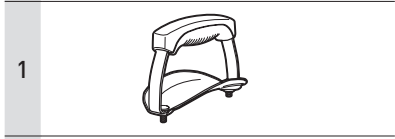

**BG** ПРИЛОЖЕНИ ИНСТРУМЕНТИ: **LT** PRIDEDAMI ĮRANKIAI:  
**CS** NÁŘADÍ V SADE: **LV** IEKĻAUTIE RĪKI:  
**EL** ΕΡΓΑΛΕΙΑ ΠΟΥ ΠΕΡΙΛΑΜΒΑΝΟΝΤΑΙ: **RO** UNELTE ÎNCLUSE:  
**ET** KAASASOLEVAD TÕÕRIISTAD: **SK** NÁRADIA V SADE:  
**HR** UKLJUČENI ALATI: **SL** PRILOŽENO ORODJE:  
**HU** A MELLÉKELT ESZKÖZÖK: **TR** ÜRÜNE DAHİL ALETLER:



**BG** НЕОБХОДИМИ ИНСТРУМЕНТИ: **LT** REIKALINGI ĮRANKIAI:  
**CS** POTŘEBNÉ NÁŘADÍ: **LV** NEPIECIEŠAMIE INSTRUMENTI:  
**EL** ΕΡΓΑΛΕΙΑ ΠΟΥ ΑΠΑΙΤΟΥΝΤΑΙ: **RO** UNELTE NECESARE:  
**ET** VAJALIKUD TÕÕRIISTAD: **SK** POTREBNÉ NÁSTROJE:  
**HU** SZÜKSÉGES SZERSZÁMOK: **SL** POTREBNO ORODJE:  
**HR** POTREBNI ALATI: **TR** GEREKLİ ALETLER:

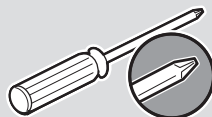

2



2

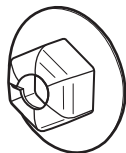

3

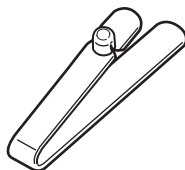

3



**BG** Изтеглете безплатното приложение BILT за 3D инструкции стъпка по стъпка.

**CS** Stáhněte si zdarma aplikaci BILT a získejte 3D návody krok za krokem.

**EL** Κατεβάστε τη δωρεάν εφαρμογή BILT για 3D οδηγίες βήμα προς βήμα.

**ET** Laadige alla tasuta rakendus BILT sammhaaval läbitavate 3D juhiste saamiseks.

**HR** Preuzmite besplatnu aplikaciju BILT za 3D upute korak po korak.

**HU** Töltse le az ingyenes BILT appot, a 3D-s, lépésenkénti, részletes útmutató megtekintéséhez!

**LT** Atsisiųskite nemokamą BILT programėlę su nuosekliomis trimatėmis instrukcijomis.

**LV** Lejupielādējiet bezmaksas programmu BILT, lai saņemtu detalizētus 3D norādījumus.

**RO** Descărcați aplicația gratuită BILT pentru instrucțiuni 3D, pas cu pas.

**SK** Stiahnite si zadarmo aplikáciu BILT, ktorá obsahuje 3D pokyny krok po kroku.

**SL** Prenesite si brezplačno aplikacijo BILT za 3D-navodila po korakih.

**TR** Adım adım 3D talimatlar için ücretsiz BILT uygulamasını indirin.

2

3-

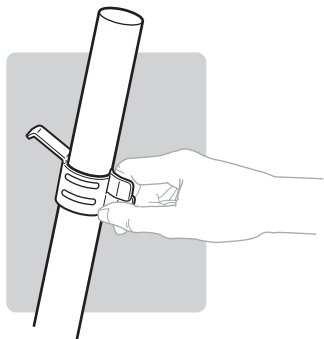
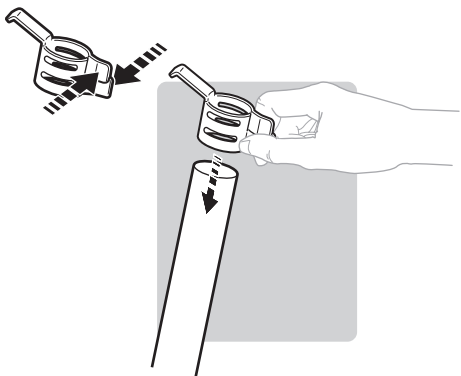
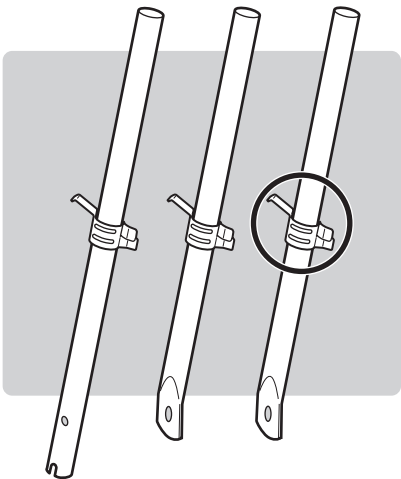

3

1-

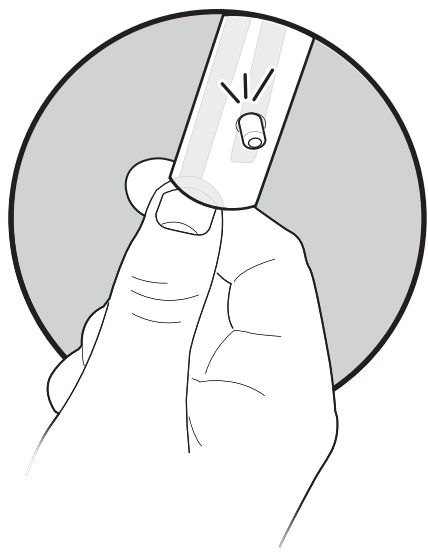
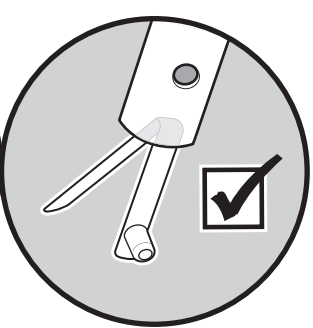
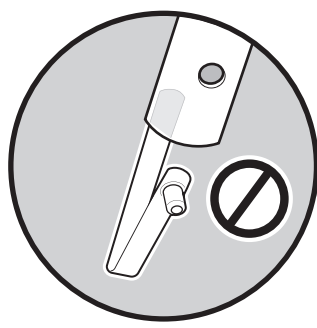
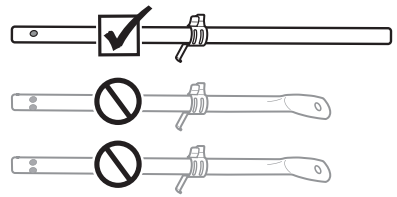
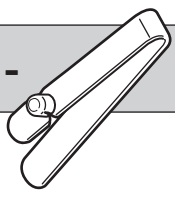

4

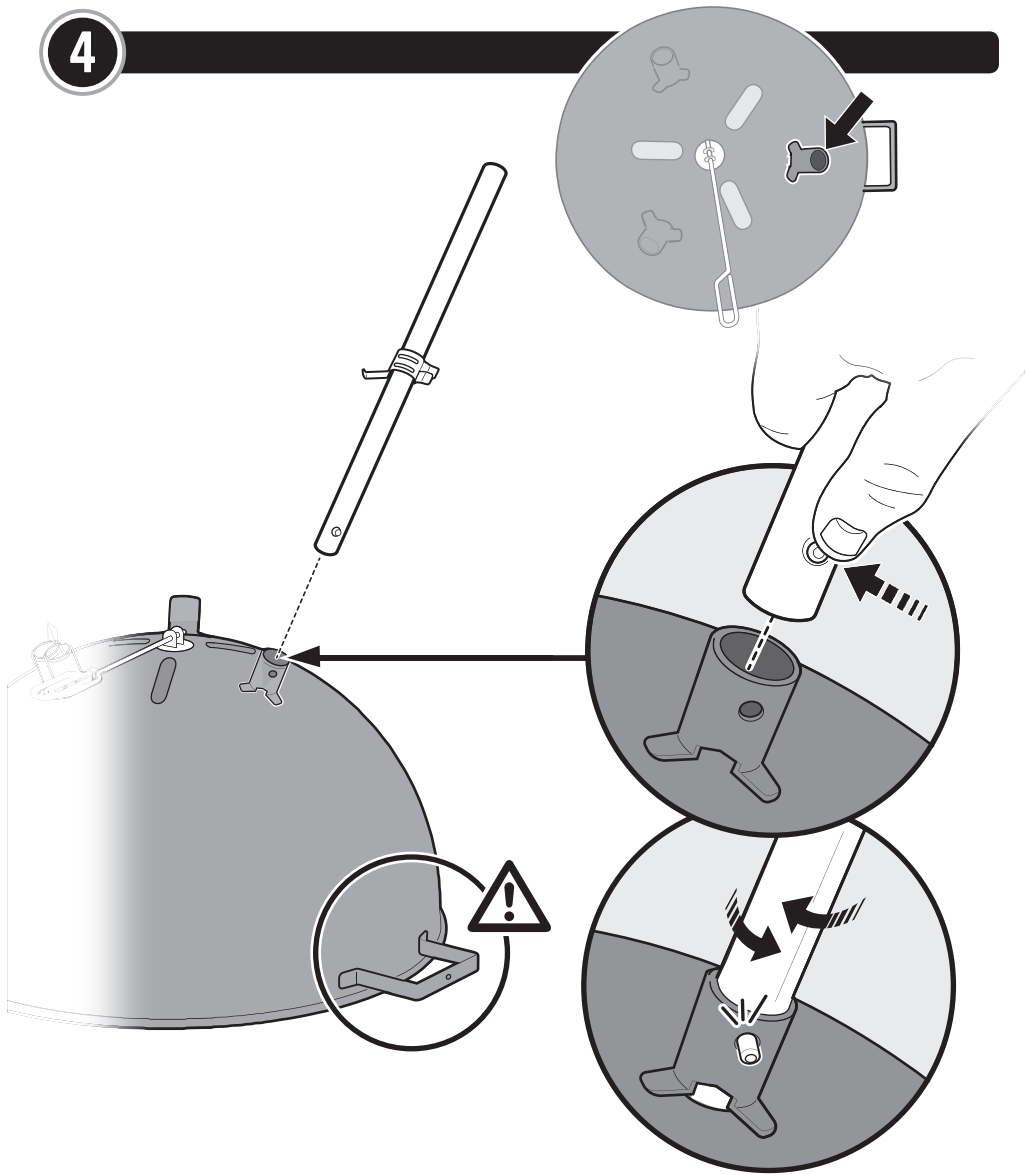

5

1-

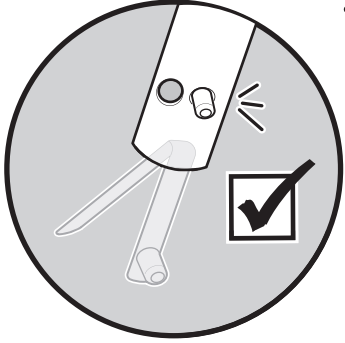
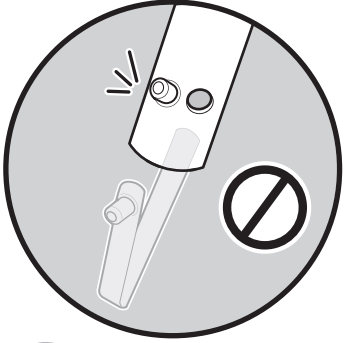
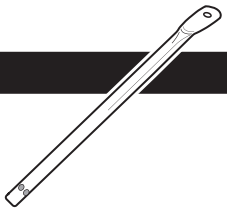
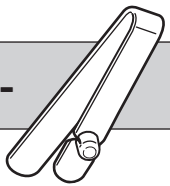

6

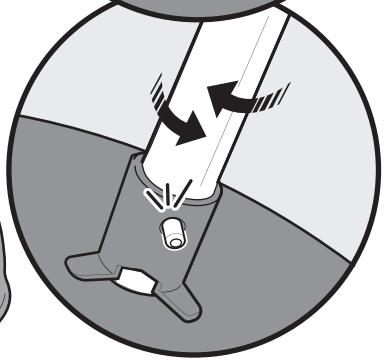
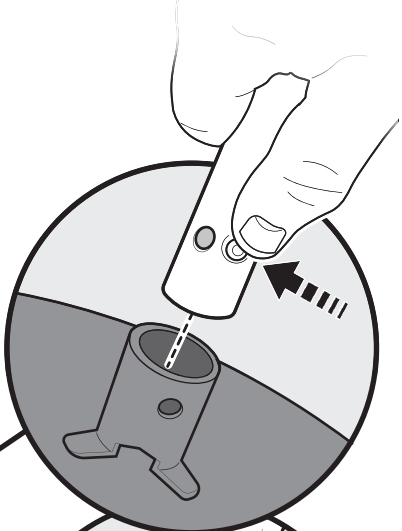
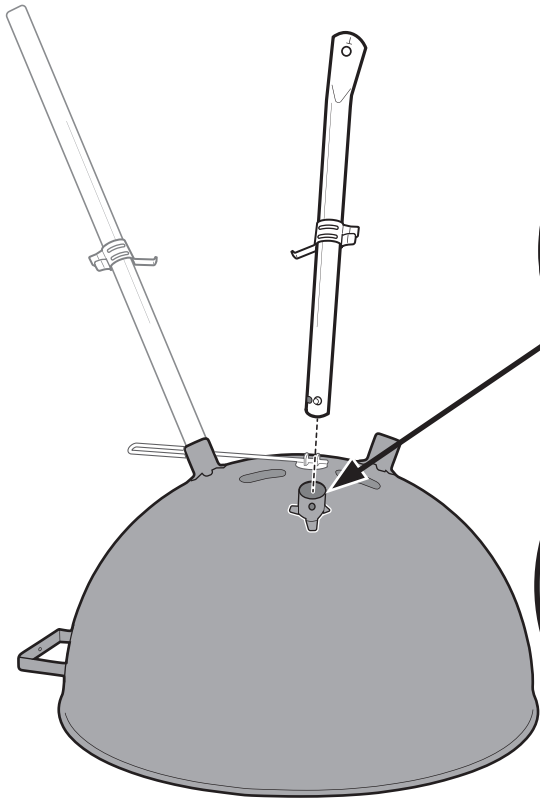

7

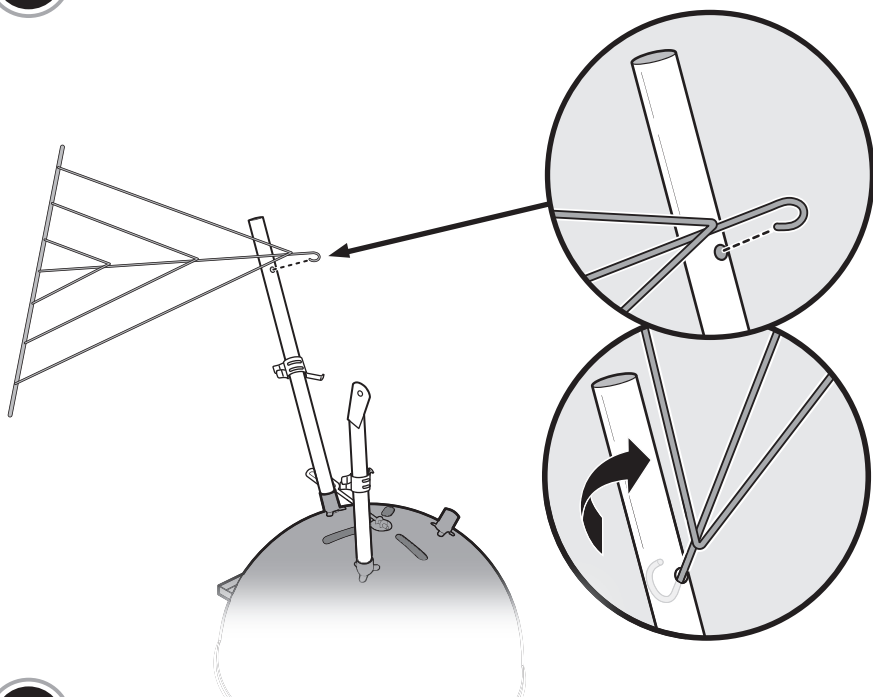

8

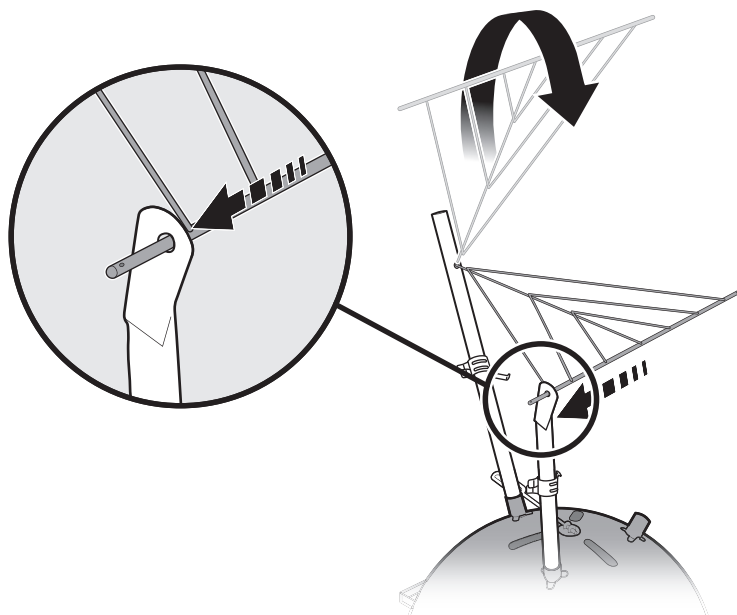



9

1-

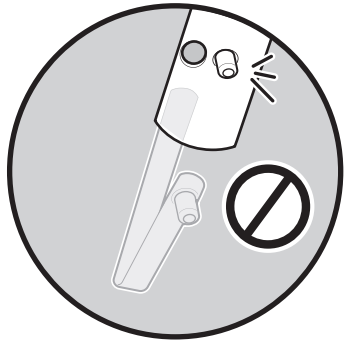
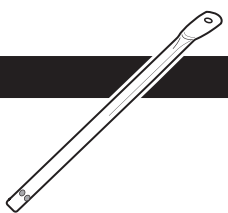
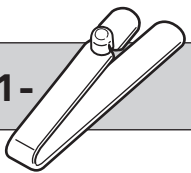

10

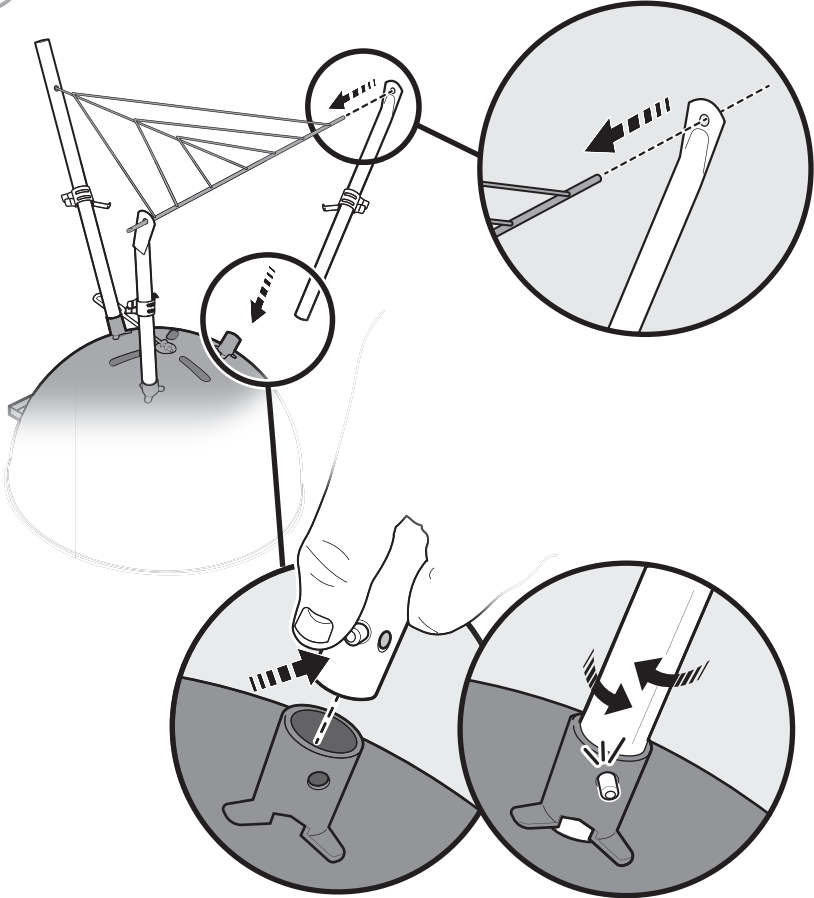

11

2-  2- 

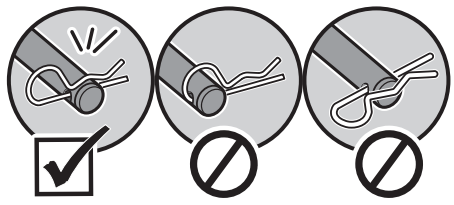
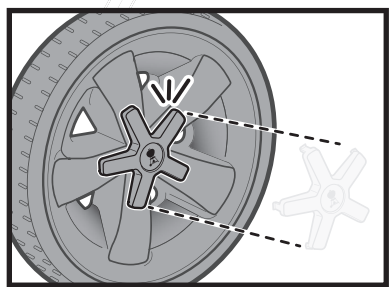
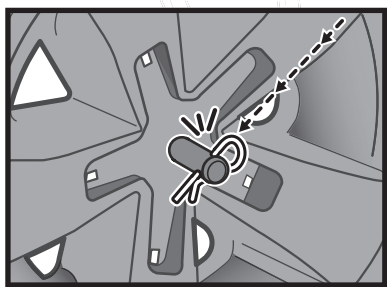
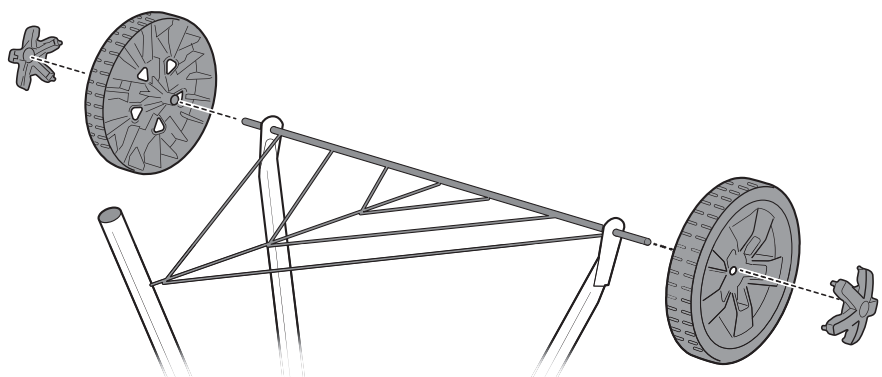

12

1- 

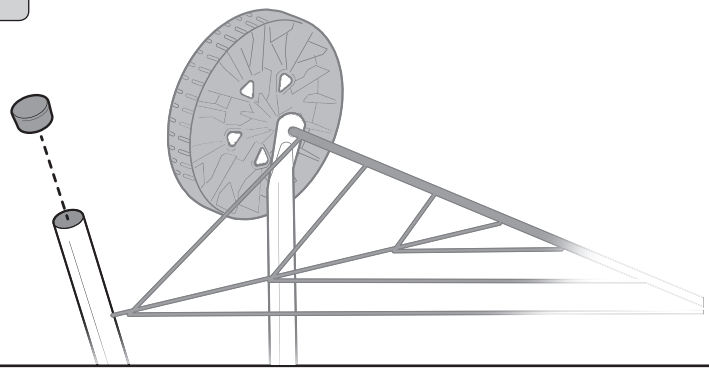

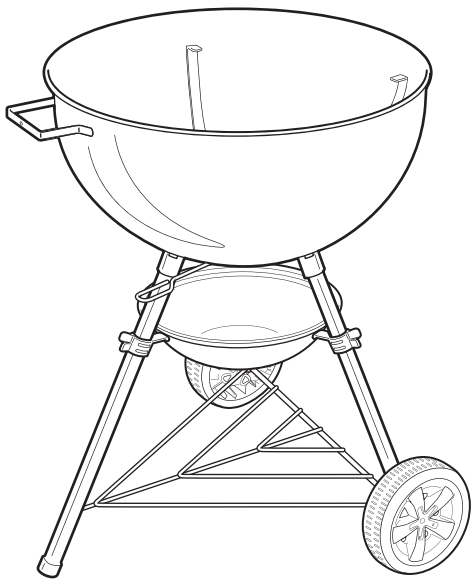
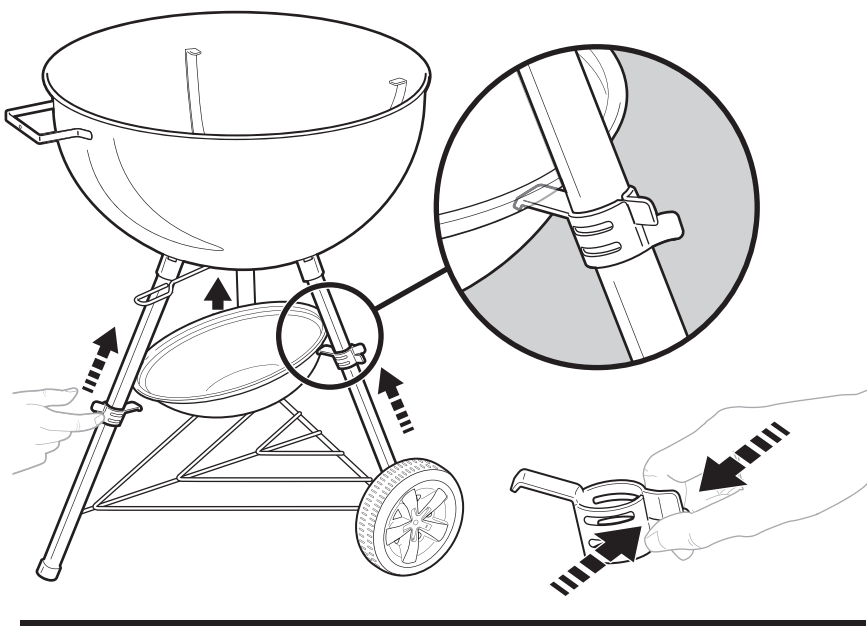

14

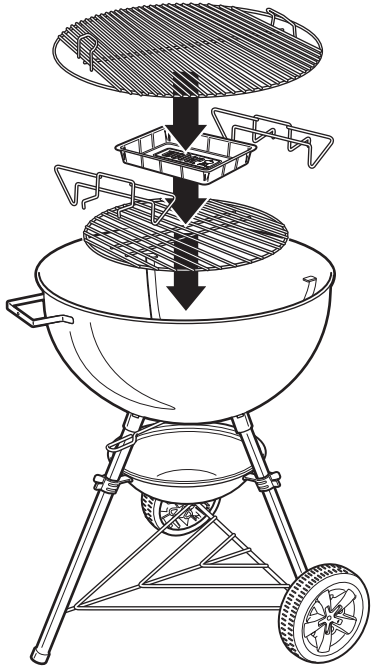

15

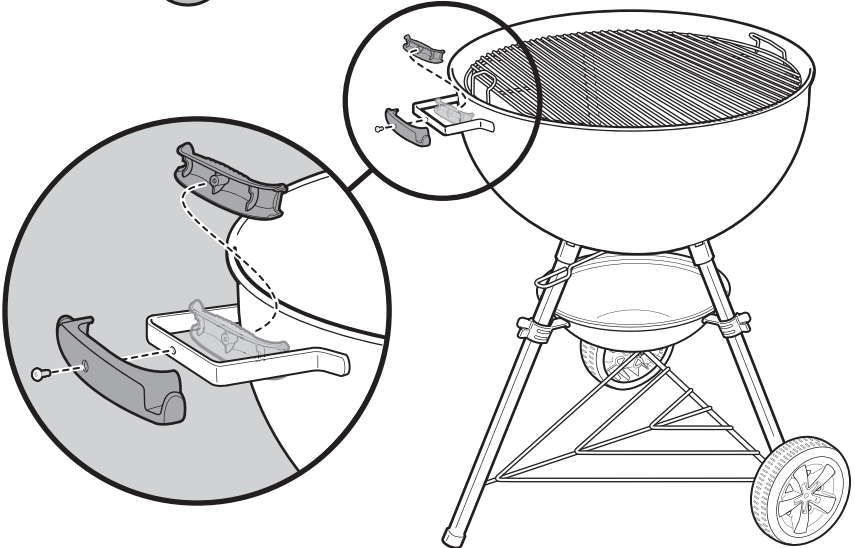

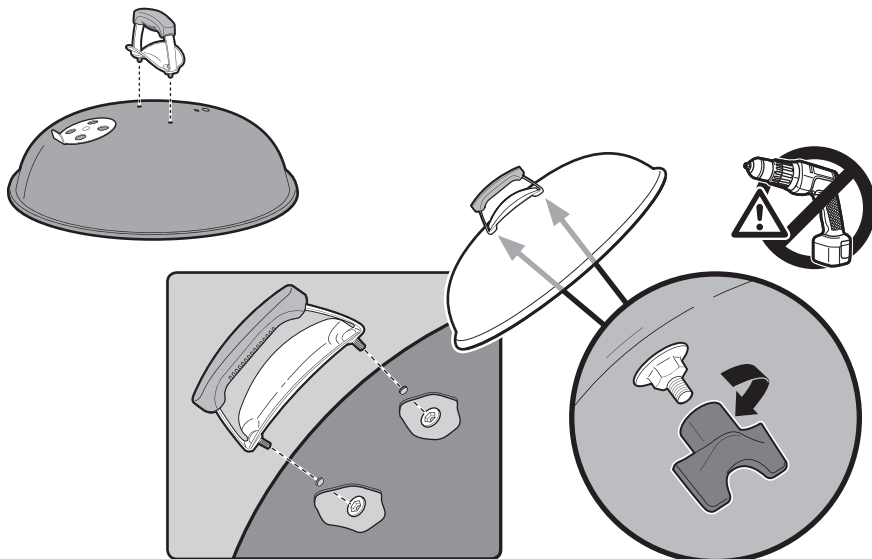

- BG** Затегнете крепежите до стегнато положение.  
 ⚠ **НЕ ПРЕНАТЯГАЙТЕ КРЕПЕЖИТЕ.**
- CS** Utahujte šrouby dokud nebudou zajištěny na místě.  
 ⚠ **ŠROUBY NEUTAHUJTE PŘILÍŠ.**
- EL** Σφίξτε τα συνδετικά στοιχεία μέχρι να είναι σταθερά.  
 ⚠ **ΜΗΝ ΣΦΙΓΓΕΤΕ ΥΠΕΡΒΟΛΙΚΑ ΤΑ ΣΥΝΔΕΤΙΚΑ ΣΤΟΙΧΕΙΑ.**
- ET** Pingutage seadmestikku, kuni see on turvaliselt kinni.  
 ⚠ **ÄRGE PINGUTAGE SEADMESTIKKU LIIGSELT.**
- HR** Zategnite čvrste dijelove tako da su sigurno pričvršćeni.  
 ⚠ **NEMOJTE PREVIŠE ZATEGNUTI ČVRSTE DIJELOVE.**
- HU** Húzza meg a fém alkatrészeket, hogy biztosan rögzítve legyenek.  
 ⚠ **NE FESZÍTSE TÚL A FÉM ALKATRÉSZEKET!**
- LT** Priveržkite įrangą, kad ji laikytųsi tvirtai.  
 ⚠ **NEGALIMA PERNELYG PRIVERŽTI ĮRANGOS.**
- LV** Pievelciet stiprinājumus, līdz tie ir stingri.  
 ⚠ **NEPĀRVELCIET STIPRINĀJUMUS.**
- RO** Strângeți armăturile până ce se fixează.  
 ⚠ **NU STRÂNGEȚI EXAGERAT ARMĂTURILE.**
- SK** Utahujte skrutky kým nebudú zaistené na mieste.  
 ⚠ **SKRUTKY NEUTAHUJTE PŘILÍŠ.**
- SL** Okovje privijte tako, da je varno pritrjeno.  
 ⚠ **NE PRIVIJTE GA PREVEČ.**
- TR** Vidaları sağlam bir şekilde yerine oturana kadar sıkın.  
 ⚠ **VİDALARI AŞIRI SIKMAYIN.**

17

1-

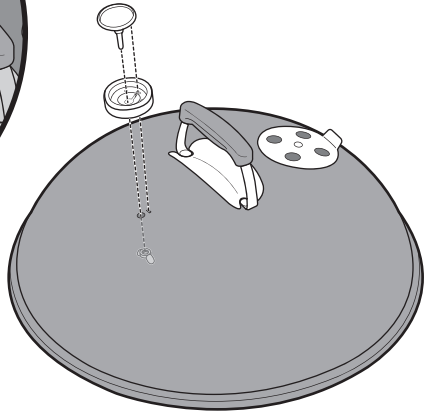
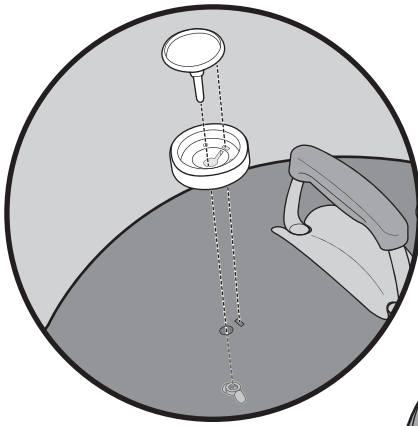

18

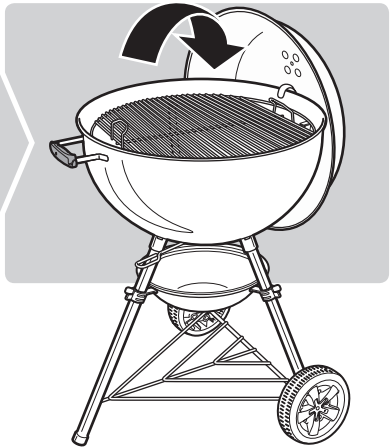
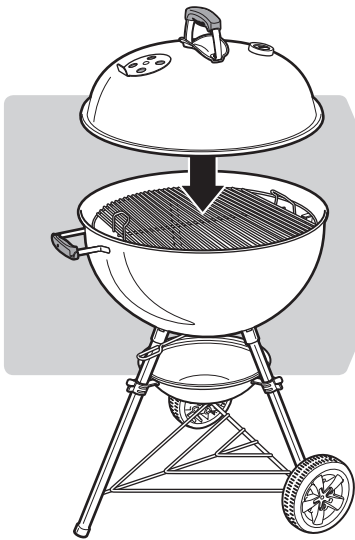

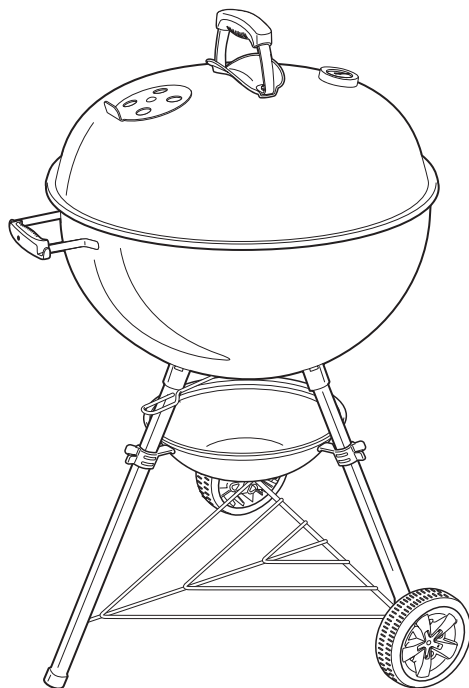

**BG** Уверете се, че всички части са сглобени и крепежите са добре затегнати, преди да пуснете барбекюто в действие.

**CS** Ještě před použitím grilu se ujistěte, že jsou všechny díly správně smontované a šroubky jsou pečlivě dotažené.

**EL** Βεβαιωθείτε ότι όλα τα εξαρτήματα έχουν συναρμολογηθεί και τα συνδετικά στοιχεία έχουν σφίξει πλήρως πριν λειτουργήσετε την ψησταριά.

**ET** Veenduge enne grilli kasutamist, et kõik osad oleksid omavahel ühendatud ja seadmestik oleks täielikult pingutatud.

**HR** Pobrinite se da svi dijelovi budu sastavljeni, a oprema potpuno pričvršćena prije početka upotrebe roštilja.

**HU** Ellenőrizze, hogy minden alkatrész a helyén van-e és a fém alkatrészek teljesen meg vannak-e szorítva, mielőtt használatba veszi a grillt!

**LT** Įsitinkite, kad visos dalys yra surinktos ir pritvirtintos prieš naudojantis kepsnine.

**LV** Pirms grila lietošanas pārlicinieties, ka visas daļas ir samontētas un ierīce pilnībā nostiprināta.

**RO** Asigurați-vă că toate piesele sunt asamblate și că armăturile sunt strânse complet înainte de a pune în funcțiune grătarul.

**SK** Pred prvým použitím grilu sa uistite, že všetky diely sú zmontované a skrutky sú plne utiahnuté.

**SL** Pred uporabo žara se prepričajte, da so vsi deli sestavljeni in je okovje dobro pritrjeno.

**TR** Barbeküyü kullanmadan önce tüm parçaların monte edildiğinden ve iyice sıkıştırıldığından emin olun.



WEBER-STEPHEN PRODUCTS LLC  
[www.weber.com](http://www.weber.com)

© 2019 Designed and engineered by Weber-Stephen Products LLC,  
1415 S. Roselle Road, Palatine, Illinois 60067 USA.